

Service  
Service  
Service



# Service Manual



## TABLE OF CONTENTS

	Page
Version Variation.....	1-2
Technical specification .....	1-3..1-13
Safety instruction.....	2-1
ESD protection.....	2-2
Set Block diagram .....	3-1
Set Wiring diagram.....	4-1
Disassembly diagram .....	5-1
Circuit diagram.....	6-1..6-3
Layout diagram.....	6-4..6-7
Mechanical Exploded view.....	7-1



© Copyright 2012 Philips Consumer Electronics B.V. Eindhoven, The Netherlands  
All rights reserved. No part of this publication may be reproduced, stored in a retrieval system or transmitted, in any form or by any means, electronic, mechanical, photocopying, or otherwise without the prior permission of Philips.

Published by LX 1203 Service Audio Subject to modification

3141 785 37200

Version 1.0



# PHILIPS



**MCM1110 SH 190 Content List (Version:1.0)**

No.	Descrpitopn	Page
1	GENERAL PART 1 - FRONT PANNEL SPECIFICFICATION	1
2	GENERAL PART 2 - BACK PANNEL SPECIFICFICATION	2
3	GENERAL PART 3 - GENERAL SPECIFICFICATION	3
4	GENERAL PART 4 - TECHNICAL SPECIFICFICATION	4
5	GENERAL PART 5 - AUDIO SIGNAL SPECIFICFICATION ( 1 )	5
6	GENERAL PART 6 - USB SPECIFICFICATION	6
7	GENERAL PART 7 - CLOCK / TIMER SPECIFICFICATION	7
8	GENERAL PART 8 - TUNER TUNER SPECIFICFICATION	8
9	GENERAL PART 9 - CD / MP3 SPECIFICFICATION	9
10	GENERAL PART 10 - VERSION OVERVIEW SPECIFICFICATION	10

DEPICTION	Pos	Description	Page
	1		Page
	2		
	3		
	4		
	5		
	6		
	7		
	8		
	9		
	10		
	11		
	12		
	13		
	14		
	15		
	16		
	17		
	18		
	19		
	20		
	21		
	22		
	23		
	24		
	25		
	26		
	27		
	28		
	29		

CABINET			
Diemensions with Boxes ( wxhxd ) --mm X --mm X --mm	Material : HIPS / ABS / POM / V2 / SAN		
Diemensions without Boxes ( wxhxd ) __mm X __mm X __	Finishing : Chrome Plate		
Weight ( inclusive packing )	Units in Masstercarton		
Weight ( exclusive packing & batery )	Units in Dealercarton		

Remarks :			
1	used into DCB146 all version		

Remark :

GENERAL PART 1 - FRONT PANNEL SPECIFICATION					
Class No	MCM1110 All Version			Ver	Issued Date
				1	5-Sep-11
				2	-----
				3	-----
NAME : DS.XIE	10	10	SH 190 - 1		A4
CHECK:	DATE :				

DEPICTION	Pos	Description	Page
	1		
	2		
	3		
	4		
	5		
	6		
	7		
	8		
	9		
	10		
	11		
	12		
	13		
	14		
	15		
	16		
	17		
	18		
	19		
	20		
	21		
	22		
	23		
	24		
	25		
	26		
	27		
	28		

<b>CABINET</b>			
Diemensions with Boxes ( wxhxd ) __mm X __mm X __mm		Material :HIPS	
Diemensions without Boxes ( wxhxd ) __mm X __mm X __		Finshing : Chrome Plate	
Weight ( inclusive packing )		Units in Masstercarton	
Weight ( exclusive packing & batery )		Units in Dealercarton	

GENERAL PART 1 - BACK PANNEL SPECIFICATION							
Class No	<b>MCM1110 All Version</b>				Ve	Issued Date	
					1	5-Sep-11	
					2		
		3					

NAME : DS.XIE		10	10	SH 190 - 2	A4
CHECK:	DATE :				

<b>GENERAL DESCRIPTION</b>						
MICRO System with Digital Tuner, Clock Timer , ipod , RMS 2 x 5W Universal Class D Power Amplifier Aux In and Remote Control						
LIFETIME : 7 Years						
Class	Tuner	Supply + Amplifier	Loudspeaker Boxes	Recorder	Clock	CD / MP3
I			X	X		
II	X	X			X	X
III						
Page	12	4,5	4	6	7	8,9,10,11
<b>SAFETY requirements</b>						
Version	Safety			EMC		
/98	EN 60065			CISPR 13		
/55	EN 60065			CISPR 13		
/12	EN 60065			EN 55013 / EN 55020		
/05	EN 60065			EN 55013 / EN 55020		
/79	EN 60065			CISPR 13		
/61	EN 60065			CISPR 13		
<b>RADIATION / IMMUNITY requirments ( EMC )</b>						
<b>CLIMATIC requirements</b>						
ALL climates : + 5 Dregree till + 35 Degree						
MODERATE climates : + N.A till N.A Degree						
<b>PERFORMANCE CLASSES</b>						
<b>POWER SUPPLY</b>						
MAINS ( A.C. )				230 Vac ± 15 %		
Version				/ 12 /05		
Voltage Selection				No		
Frequency				50 Hz		
<b>POWER CONSUMER</b>						
Standby :		< =1W				
( DEMO mode " OFF " ) , NOM. A, INPUT		nc				
Maximum :						
@ 1/8 Prated , NOM. A, INPUT		25W				
ECO Power mode :		<=0.5W				
Q and R according to Product Division Rules						
Quality : 0.4 % ( Major ) 1.5 % ( Mirror )						
Reliability : 2.0 % ( C 42 )						
Tested according to General Test Instruction refer to PHILIPS standary ( UAN -D1591 )						
Measured according to PHILIPS standary ( UAN - L1059 ) unless other wise stated						
All not mentioned date, please refer to PHILIPS standary ( XUW - 0010 - MAR 1995 )						
DERIVED		REMARKS			APPROBATION	
Remarks						
GENERAL PART 1 - GENERAL SPECIFICATION						
Class No	<b>MCM1110 All Version</b>			Ver	Issued Date	
				1	5-Sep-11	
				2	#REF!	
				3	#REF!	
NAME : DS.XIE		10	10	SH 190 - 3	A4	
CHECK		DATE :				

TECHNICAL DESCRIPTION					
2 x 5W , matching LOUDSPEAKER of 2 x 4ohm. One INPUT SOURCE, ( Digital Sound Control ).					
GENERAL PART					
OUTPUT stage Protection	: NO	Temperature	: No.	Shorcircuit	: Yes
LoudSpeaker D.C. Protection	: NO.				
INDICATORS					
Standby Mode Indicator	: LCD display time				
ECO Mode Indicator	: N/A				
ELECTRICAL DATA					
DSC :	Jazz,Rock,Clas,POP	Channel Differencer at -46dB	3	dB	
DBB	ON/OFF	Hum ( -20 Volume )(FILTER)	3	mv	
SIS :	N/A	Residual Noise ( Volume Minium )(FILTER)	1.5	mv	
VAC :	N/A	Channel Separation ( at 1 kHz )	≥ 30	dB	
WOOX :	N/A	Signal / Noise ( weighted )(FILTER)	≥ 50	dB	
INTERCONNECTS					
Input Sensitivity ( ±3dB ) rated ouput power at 1 kHz		Line Output Voltage ( *1 )			
Tuner	: FM 67.5KHz,AM 80% Modulation	Line Out ( Left / Right )	N.A		
CD	: -6 dB track ( Audio Disc 1, Trk 15 )	Subwoofer Out	N.A		
TAPE	: N/A	Headphone(at CD 0dB input)	N/A		
USB	: N/A	Digital Coaxial Out	N.A		
AUX	: 500 mV ± 2 Db(lim:650mv)	Booster Out	N.A		
Microphone	: N/A				
OUTPUT POWER ( *1 ) At THD = 10% , 1KHz sinewave					
Main Operation ( for DCB188/05/12 )	: 5W, 2 Channels	( At Cold Condition with 10% THD )			
Frequency Response:	: 60Hz - 16KHz	( At 500mV Output in FLAT Mode )			
LOUDSPEAKER ( BOXES )		Please to package document of Speaker Box Assy			
Rated Impedance					
Left / Right : 4 ohma at 63Hz to 20KHz					
Remarks					
(*1) Electrical parameters are to be measurment at specker terminals across 8 Ohr 4 Ohm load with rated input signal in AUX mode; DSC setting in Jazz mode with DBB OFF At 10% THD DIST O/P POWER 2X5W					
(*2) Input Sensity rated, Tuner is +/-6dB					
GENERAL PART 1 - GENERAL SPECIFICATION					
Class No	MCM1110 All Version			Ver	Issued Date
				1	5-Sep-11
				2	#REF!
		3	#REF!		
NAME : DS.XIE	10	10	SH 190 - 4	A4	
CHECK	DATE :				

AUDIO SIGNAL PROCESSING

MICRO System with Digital Tuner, Clock Timer ,ipod, 2 x 5W Universal Class D Power Amplifier

Aux In, Head Phone and Remote Control

1) DSC ( Digital Sound Control )

Select AUX as input source with the following set conditions:

Inject sine wave 600mV at 1 KHz to L/R channels of AUX-IN socket.

Set DSC to CLAS(Flat) mode and switch off DBB,OSM&INCREDIBLE SURROUND.

Refence level for DSC's without DBB on=500mW(Volume 15).

Refence level for DSC'S with DBB on=1V at the speaker terminal (Volume 15).

Inject sine wave 600mV to AUX-IN socet with frequencies indicated in Table 1.

Tabel 1a ( Tolerance  $\pm$  3dB ) without Test

Frequency	DSC Modes with DBB Off			
	JAZZ	ROCK	CLAS	POP
125 Hz	3	7	0.1	5
1 kHz	-0.3	2	0	1.4
10 kHz	-2.2	2.5	-0.3	2

Tabel 1b ( Tolerance  $\pm$  3dB ) without Test

Frequency	DSC Modes with DBB ON			
	JAZZ	ROCK	CLAS	POP
125 Hz	8	10	6	10
1 kHz	0.5	2.4	0.6	2
10 kHz	-0.2	5	0.2	4

2) DBB ( Dynamic Bass Boot )

Select AUX as input source with the following set conditions :

Inject sine wave 600mV at 1kHz to L/R channels of AUX - IN socket.

Set DSC to CLAS(Flat) mode and switch off DBB,

Adjust volume level will be as 0dB reference.(Volume 15).

Tabel 2 ( Tolerance  $\pm$  3dB )

Frequency	DBB OFF	DBB ON
125 Hz	0	+ 6 dB

Remarks

GENERAL PART 1 - GENERAL SPECIFICICATION

Class No				Ver	Issued Date
	<b>MCM1110 All Version</b>			1	5-Sep-11
				2	#REF!
				3	#REF!
NAME : DS.XIE	10	10	SH 190 - 5		A4
CHECK	DATE :		ART Electronics Co. Ltd.		



TECHNIAL DESCRIPTION

USB - Part Specifications

GENERAL PART

Description	Extern	Nom	Lim	Unit
Channel Unbalance		3	< ± 2	dB
Frequency Response ( 125 Hz - 16 kHz )		0	± 3	dB
Signal to Noise Ration ( Unweighted )	FILTER	55	50	dB
Signal to Noise Ration ( A - weighted )	FILTER	60	55	dB
Channel Separation 1KHz	FILTER	50	45	dB
Hum & Noise (min vol )	FILTER		≤1.5	mv
Hum & Noise (max vol )	FILTER		≤3	mv
THD 1KHz	FILTER	0.2	1	%

Remark: Frequency response at VOLmax

USB SPECIFICATION

Class No	MCM1110 All Version				Ver	Issued Date
					1	5-Sep-11
					2	
					3	
NAME : DS.XIE	10	10	SH 190 - 6			A4
KT		CHECK				

TECHNIAL DESCRIPTION

SOFTWARE IMPLEMENTED CLOCK / TIMER FUNCTION WITH 32.768KHz QUARTZ OSCILLATOR.

GENERAL PART

Timer Setting	:	Clock and Timer
Timer Wakeup Mode	:	CD & Tuner mode
Remarks Time Setting	:	24hrs
Volume at Wakeup	:	Default Setting(VOL12)
No of Timer Settings	:	1
Clock Accuracy	:	Nom : 2 sec/day                      Limit : 4 sec/day

INDICATORS

Display Type	:	LCD
--------------	---	-----

Remark

CLOCK / TIMMER SPECIFICATION

Class No	MCM1110 All Version				Ver	Issued Date
					1	5-Sep-11
					2	#REF!
					3	#REF!
NAME : DS.XIE		10	10	SH 190 - 7		A4
CHECK:		DATE :				

TECHNICAL DESCRIPTION								
GENERAL PART								
WAVE RANGE(/05 VERSION)		TOLERANCE			TUNING GRID			
FM	87.5 - 108.00 MHz	QUARTZ PRECISION			50 kHz			
AERIAL								
FM	: T TYPE ANT WIRE 75 Ohm							
INDICATORS								
LCD								
ELECTRICAL DATA								
DAB		Nom	Limit	Unit	F.M.	Nom	Limit	Unit
DAB Modes:Supports modes I,II,III,IV				dB	- 3 dB Limiting Point	: 17	23.5	dBf
Frequency Range:Band III (174~240MHz)				dB	Amplification Reverse	: 0	-4	dB
Sensitivity:(EN50248)				dBm	Distortion ( RF 1mV, Frq Dev.75 kHz )	: 2	3	%
Max In Signal:After Error Correction				dBm	Stereo - 46 dB Quieting	: 46	49	dBf
Adjacent Channel Selectivity:(EN50248)				dB	Crosstalk (RF1mV, Freq Dev. 67.5kHz )	: 25	18	dB
Far-off Selectivity : (EN50248)				dB	IF	: 10.7	± 0.1	MHz
Acquisition Time after synchronization loss:				S	Modulation Hum	: 50	40	dB
Signal to Noise with Filter (A-Wighted)				dB	S/N Ratio	: 45	40	dB
Channel Separation with Filter (A-Wighted)				dB	Search Tuning Sensitivity(at stereo mode)	: 26	+/-10	dB
Overall Distortion:				%				
Max Data bit rate :				bit/s				
Wave Range		Noise Limited Sensitivity 26 dB		Image Rejection(dB)	IF Rejection(dB)	Large Signal	Selectivity (dB)	
FM 90.1 MHz	Nom.		16dB	40	65	116 dBf	24	
	Lim.		22dB	25	45	108 dBf	20	
FM 98.1 MHz	Nom.		16dB	40	65	116 dBf	24	
	Lim.		22dB	20	45	108 dBf	20	
FM 106.1 MHz	Nom.		16dB	40	65	116 dBf	24	
	Lim.		22dB	20	45	108 dBf	20	
Remarks : tuner FM -6dB max senscitivity for all about test.								
TUNER SPECIFICATION								
Class No		<b>MCM1110 All Version</b>				Ver	Issued Date	
						1	5-Sep-11	
						2		
					3			
NAME :DS.XIE		10	10	SH 190 - 8		A4		
	CHECK:	DATE :						

<b>TECHNIAL DESCRIPTION</b>					
CD Part Specifications (CD MECHAISM SANYO DA11B3VF )					
	Input	Output	Motor	Logic control	
Active components					
	Signal processing	D/A converter	HF-preamplifier	Servo processor	
Active components					
<b>AUDIO part:</b> Measurement with Audio Signals Disc-1 7104 078 04911 on speakers or Headphone socket with nom.load					
Description	Extern	Nom	Lim	Unit	
De-emphasis	15us / 50us Switchable via Subcode information				
Frequency accuracy		N/A	± 0.5	%	
Channel Unbalance		2	3	dB	
Frequency Response ( 125 Hz - 16 kHz )		0	± 3	dB	
Signal to Noise Ration ( Unweighted )	Filter	60	50	dB	
Signal to Noise Ration ( A - weighted )	Filter	65	55	dB	
Crosstalk ( 1kHz )	Filter	35	30	dB	
Crosstalk ( 10kHz )	Filter	30	16	dB	
Hum & Noise (min vol )	Filter	--	≤1.5	mv	
Hum & Noise (max vol )	Filter	--	≤3	mv	
THD (1kHz -6dB)	Filter	0.2	<1	%	
THD (10kHz -20dB)	Filter	<1	<3	%	
<b>REMARKS:</b>					
1. Amplification reserve for CD = +2dB (±2dB),Ref.Level for CD is a 0dB track instead of a -.6dB track.					
<b>Playability :(acc.To AR 30-05-239 )</b>					
	Limit	Typical	Test disc		
Wedge	600um	900um	TNO 7, 9 of SBC 444A(7104 099 24990)		
Eccentric	150um	200um	TNO 1, 24 of 200um disc (7104 099 24960)		
Fingerprint	No audible defect		TNO 11 of Sub chassis 8A		
Black dot	500um	800um	TNO 13 of SBC 444A (7104 099 24990)		
Skew 0.6mm	No audible defect		TNO 1,6 of 0.6mm skew (7104 099 28260)		
Bad HF track	No audible defect		TNO 8 of Sub chassis 8A		
Hwavy fingerprint	No track jumper/plops		TNO 10 of Sub chassis 8A		
Playback position	Solid, Normal position (Set is located on a flat surface, floor)				
1. Playback of above mentioned tracks possible without track loss or audible defects.					
2. Double black dot, max. diameter, thin/disk is according to PQR or AR 30-05-239					
3. This unit can playback (only) CD-R or CD-RW discs. For performance specification, Please refer to module specification of CD99 (3103 308 52190)					
CD SPECIFICATION					
Class No	<b>MCM1110 All Version</b>			Ver	Issued Date
				1	5-Sep-11
				2	#REF!
				3	#REF!
NAME : DS.XIE	10	10	SH 190 - 9		A4
CHECK	DATE :				

## VERSION OVERVIEW MCM1110 All Version

Ver	DEST	APPROBATION		TUNER				AC SUPPLY			MIC MIX	MATRIX SURR. SPK.
		SAFETY	EMC	Wave RANGE	GRID	AERIAL SOCKET	AERIAL SUPPLIED	MAINS VOLTAGE	SOC.	CORD		
/55 /98	OVS	EN60065 CLASS II SISR TAIWAN	CISPR 13	FM 87.5-108MHz MW 531-1602kHz or 530-1700kHz	50kHz 9kHz 10kHz	Solder PCB Board JST XH 2P Side	Pigtail Loop Sagami 18.1uH	110-127V Switched 220 - 240V 50/60Hz	IEC	IEC	No	No
/12 / 05	EUROPE	EN60065 SEMKO DEMKO NEMKO SEV BS415-UK	EN55013 EN55020	FM 87.5-108MHz MW 531-1602kHz LW 135 - 279kHz	50kHz 9kHz 3kHz	Solder PCB Board JST XH 2P Side	Pigtail Loop Sagami 18.1uH	230V/240V 50Hz	IEC	IEC	No	No
/79	AUST / NZ	EN60065 CLASS II		FM 87.5-108MHz MW 531-1602kHz or 530-1700kHz	50kHz 9kHz 10kHz	Solder PCB Board JST XH 2P Side	Pigtail Loop Sagami 18.1uH	240V/230V 50Hz	IEC	IEC	No	No
/37	USA Canada	UL 6500	FCC 99	FM 87.5-108MHz MW 530-1700kHz	100kHz 10kHz	Solder PCB Board JST XH 2P Side	Pigtail Loop Sagami 18.1uH	120V 60Hz	UL	UL	No	No
/93	China	EN60065 CLASS II	CCC	FM 87.5-108MHz MW 531-1602kHz	50kHz 9kHz	Solder PCB Board JST XH 2P Side	Pigtail Loop Sagami 18.1uH	220V 50Hz	IEC	IEC	No	No
/ 61	Korea	EN60065 CLASS II		FM 87.5-108MHz MW 531-1602kHz	50kHz 9kHz	Solder PCB Board JST XH 2P Side	Pigtail Loop Sagami 18.1uH	220V 60Hz	IEC	IEC	No	No
VERSION OVERVIEW												
Class No		<b>MCM1110 All Version</b>						Ver		Issued Date		
								1	5-Sep-11			
								2	#REF!			
								3	#REF!			
NAME : DS.XIE				10	10	SH 190 - 10				A4		
		CHECK:	DATE :									

## 2.0 SAFETY INSTRUCTIONS

**(GB)** WARNING

All ICs and many other semi-conductors are susceptible to electrostatic discharges (ESD). Careless handling during repair can reduce life drastically. When repairing, make sure that you are connected with the same potential as the mass of the set via a wrist wrap with resistance. Keep components and tools also at this potential.

**ESD****(NL)** WAARSCHUWING

Alle IC's en vele andere halfgeleiders zijn gevoelig voor electrostatische ontladingen (ESD). Onzorgvuldig behandelen tijdens reparatie kan de levensduur drastisch doen verminderen. Zorg ervoor dat u tijdens reparatie via een polsband met weerstand verbonden bent met hetzelfde potentiaal als de massa van het apparaat. Houd componenten en hulpmiddelen ook op ditzelfde potentiaal.

**(F)** ATTENTION

Tous les IC et beaucoup d'autres semi-conducteurs sont sensibles aux décharges statiques (ESD). Leur longévité pourrait être considérablement écourtée par le fait qu'aucune précaution n'est prise à leur manipulation. Lors de réparations, s'assurer de bien être relié au même potentiel que la masse de l'appareil et enfilez le bracelet serti d'une résistance de sécurité. Veiller à ce que les composants ainsi que les outils que l'on utilise soient également à ce potentiel.

**(D)** WARNUNG

Alle ICs und viele andere Halbleiter sind empfindlich gegenüber elektrostatischen Entladungen (ESD). Unsorgfältige Behandlung im Reparaturfall kann die Lebensdauer drastisch reduzieren. Veranlassen Sie, dass Sie im Reparaturfall über ein Pulsarmband mit Widerstand verbunden sind mit dem gleichen Potential wie die Masse des Gerätes. Bauteile und Hilfsmittel auch auf dieses gleiche Potential halten.

**(I)** AVVERTIMENTO

Tutti IC e parecchi semi-conduttori sono sensibili alle scariche statiche (ESD). La loro longevità potrebbe essere fortemente ridotta in caso di non osservazione della più grande cauzione alla loro manipolazione. Durante le riparazioni occorre quindi essere collegato allo stesso potenziale che quello della massa dell'apparecchio tramite un braccialetto a resistenza. Assicurarsi che i componenti e anche gli utensili con quali si lavora siano anche a questo potenziale.

**(GB)**

Safety regulations require that the set be restored to its original condition and that parts which are identical with those specified, be used.

"Pour votre sécurité, ces documents doivent être utilisés par des spécialistes agréés, seuls habilités à réparer votre appareil en panne".

**(NL)**

Veiligheidsbepalingen vereisen, dat het apparaat bij reparatie in zijn oorspronkelijke toestand wordt teruggebracht en dat onderdelen, identiek aan de gespecificeerde, worden toegepast.

**(F)**

Les normes de sécurité exigent que l'appareil soit remis à l'état d'origine et que soient utilisés les pièces de rechange identiques à celles spécifiées.

**(GB)** Warning !

Invisible laser radiation when open. Avoid direct exposure to beam.

**(D)**

Bei jeder Reparatur sind die geltenden Sicherheitsvorschriften zu beachten. Der Originalzustand des Geräts darf nicht verändert werden; für Reparaturen sind Original-Ersatzteile zu verwenden.

**(S)** Varning !

Osynlig laserstrålning när apparaten är öppnad och spårren är urkopplad. Betrakta ej strålen.

**(I)**

Le norme di sicurezza esigono che l'apparecchio venga rimesso nelle condizioni originali e che siano utilizzati i pezzi di ricambio identici a quelli specificati.

**(SF)** Varoitus !

Avatussa laitteessa ja suojalukituksen ohitettaessa olet alltiina näkymättömälle laserisäteilylle. Älä katso säteeseen!

"After servicing and before returning set to customer perform a leakage current measurement test from all exposed metal parts to earth ground to assure no shock hazard exist. The leakage current must not exceed 0.5mA."

**DK** Advarsel !

Usynlig laserstrålning ved åbning når sikkerhedsafbrydere er ude af funktion. Undgå udsættelse for strålning.

**Caution: These servicing instructions are for use by qualified service personnel only.**

**To reduce the risk of electric shock do not perform any servicing other than that contained in the operating instructions unless you are qualified to do so.**

## 2.1 ESD PROTECTION

- レンズには絶対に触れないでください。
- DO NOT TOUCH THE LENS.
- LINSE NICHT BRÜHREN.
- NE PAS TOUCHER LA LENTILLE.

When the power supply is being turned on, you may not remove this laser cautions label. If it removes, radiation of laser may be received.

### PREPARATION OF SERVICING

Pickup Head consists of a laser diode that is very susceptible to external static electrocity.

Although it operates properly after replacement, if it was subject to electrostatic discharge during replacement, its life might be shortened. When replacing, use a conductive mat, soldering iron with ground wire, etc. to protect the laser diode form damage by static electricity.

And also, the LSI and IC are same as above.

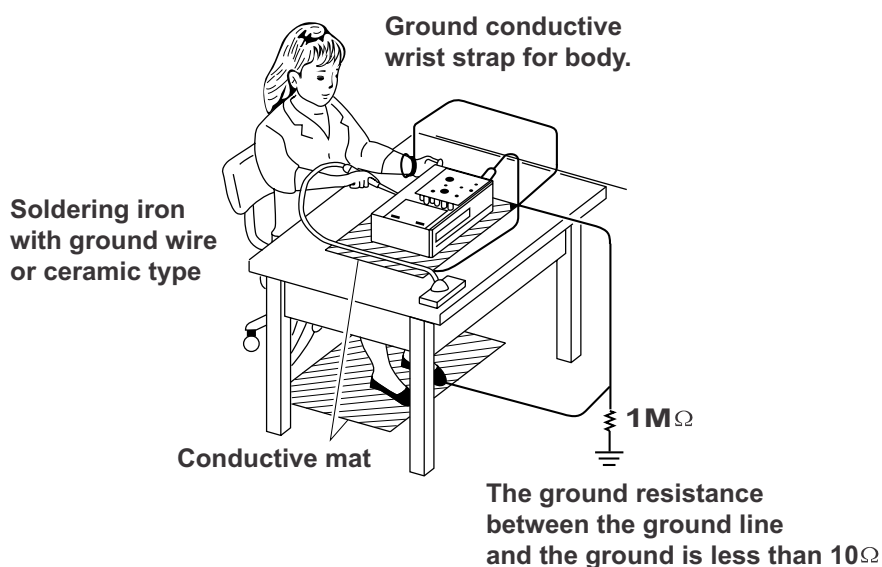

## SAFTY NOTICE

### SAFTY PRECAUTIONS

#### LEAKAGE CURRENT CHECK

Plug the AC line cord directly into a 120V AC outlet (do not use an isolation transformer for this check). Use an AC voltmeter, having  $5000\Omega$  per volt or more sensitivity. Connect a  $1500\Omega$  10W resistor, paralleled by a  $0.15\mu\text{F}$  150V AC capacitor between a known good earth ground (water pipe, conduit, etc.) and all exposed metal parts of cabinet (antennas, handle bracket, metal cabinet screwheads, metal overlays, control shafts, etc.).

Measure the AC voltage across the  $1500\Omega$  resistor. The test must be conducted with the AC switch on and then repeated with the AC switch off. The AC voltage indicated by the meter may not exceed 0.3V. A reading exceeding 0.3V indicates that a dangerous potential exists, the fault must be located and corrected. Repeat the above test with the DVD VIDEO PLAYER power plug reversed. NEVER RETURN A DVD VIDEO PLAYER TO THE CUSTOMER WITHOUT TAKING NECESSARY CORRECTIVE ACTION.

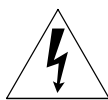
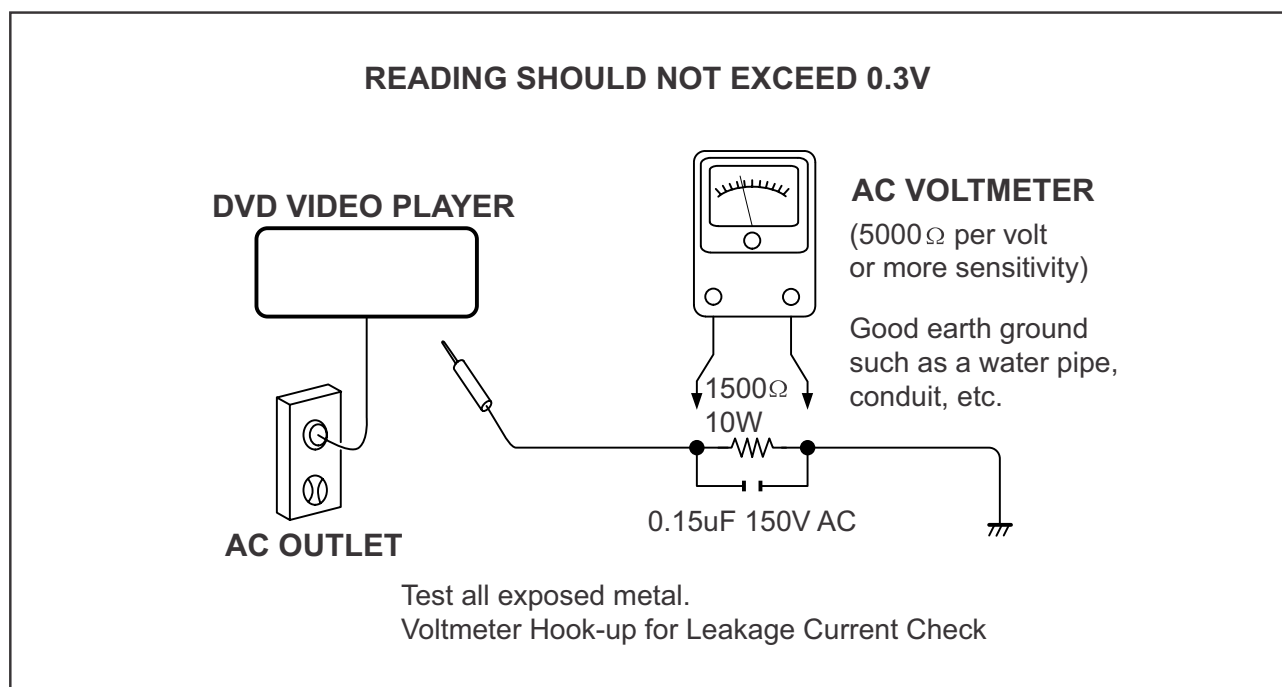

The lightning flash with arrowhead symbol, within an equilateral triangle, is intended to alert the user to the presence of uninsulated "dangerous voltage" within the product's enclosure that may be of sufficient magnitude to constitute a risk of electric shock to persons.



The exclamation point within an equilateral triangle is intended to alert the user to the presence of important operating and maintenance (servicing) instructions in the literature accompanying the appliance.



BLOCK DIAGRAM

3-1

3-1

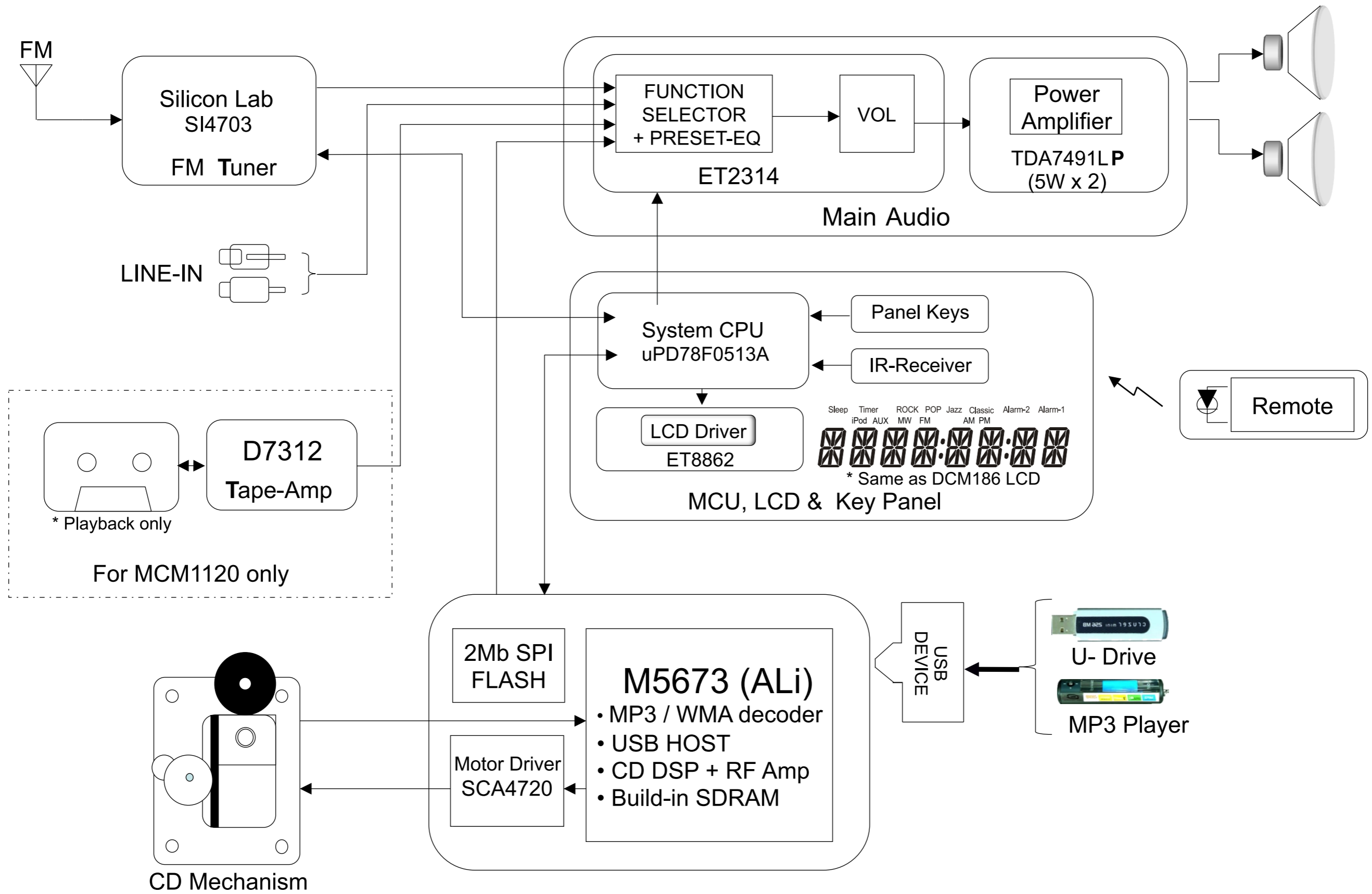

WIRING DIAGRAM

4-1

4-1

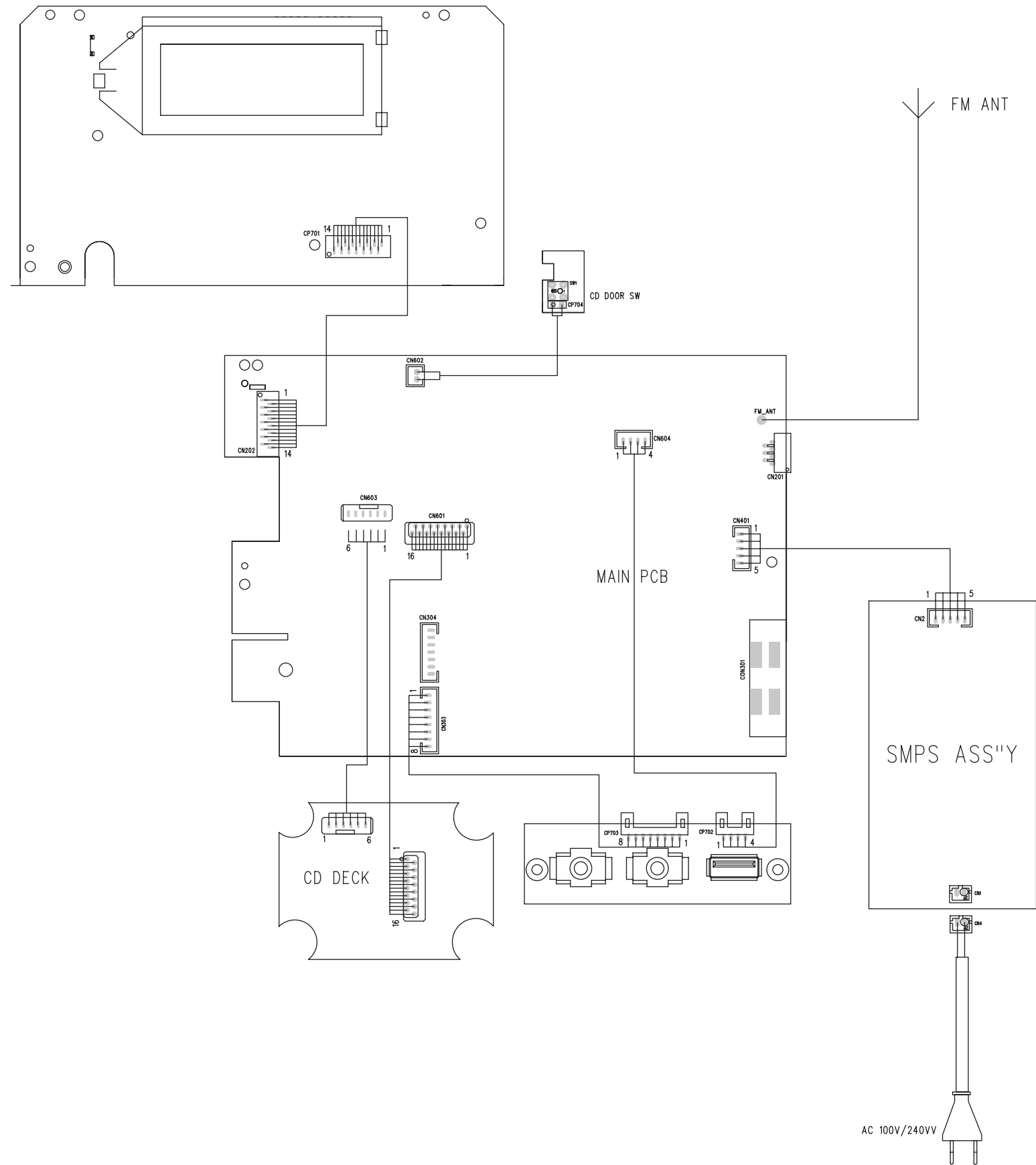

**DISASSEMBLY DIAGRAM**

Dismantling of the Rear Cabinet and CD part.

---

1) Remove 10 screws A&B&C as indicated to loosen the Rear Cabinet and CD part.

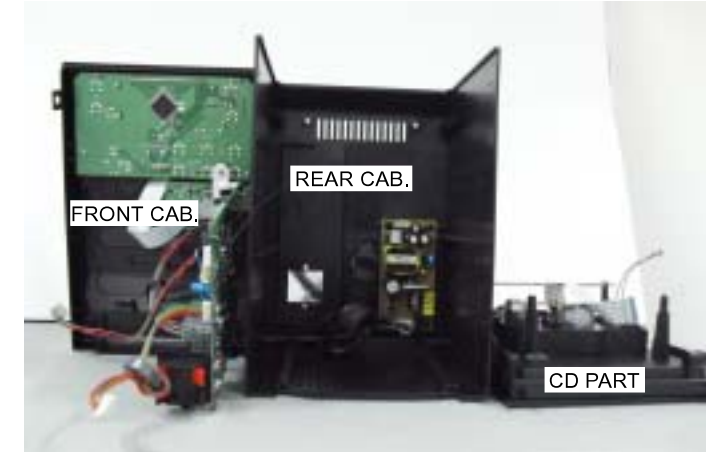
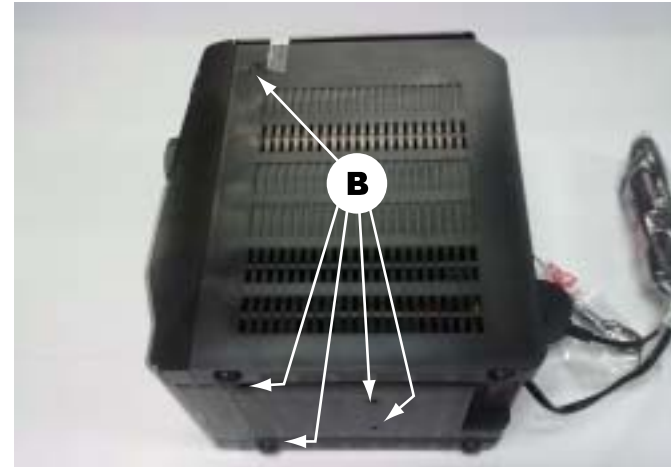
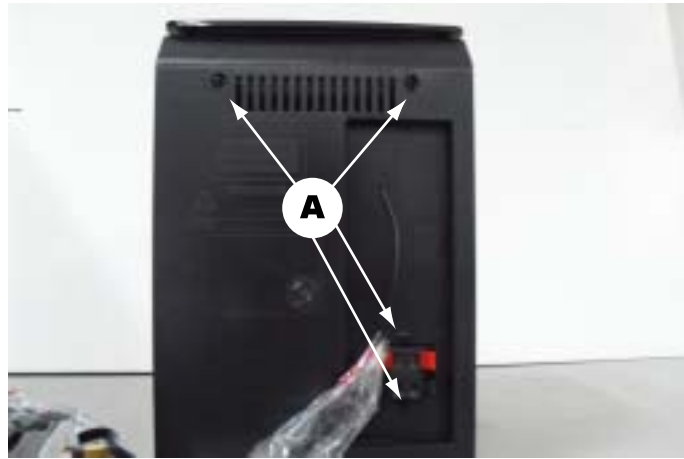
**Dismantling of the PCB Board**

1) Remove 2 screws D and 2 screws E as indicated to loosen the Main Board.

2) Remove 8 screws F as indicated to loosen the Display Board.

3) Remove 4 screws G as indicated to loosen the Smps module.

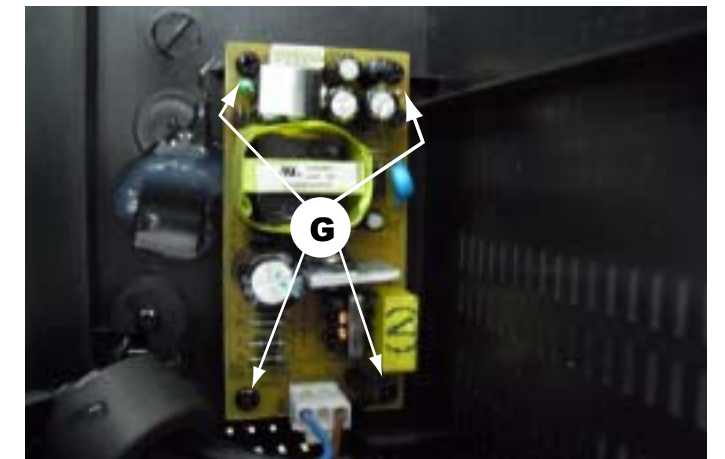
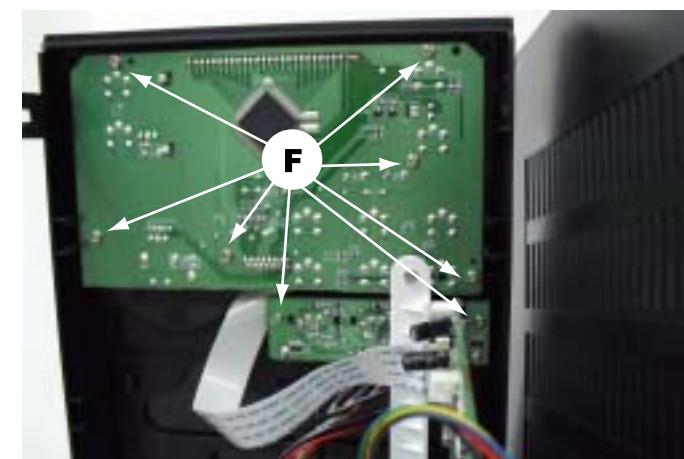
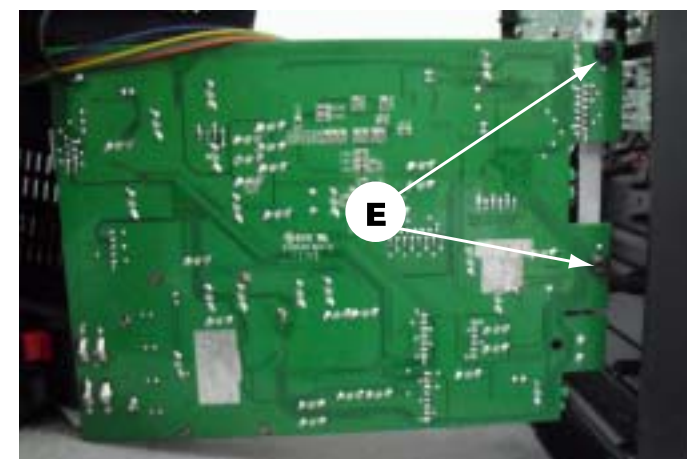
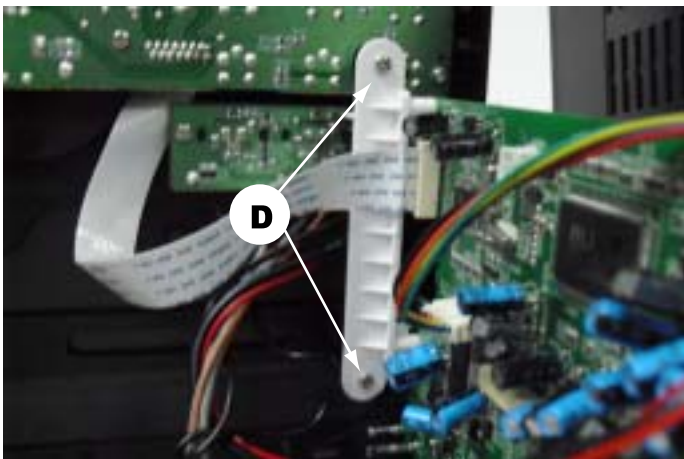

# CIRCUIT DIAGRAM - AMP/POWER BOARD

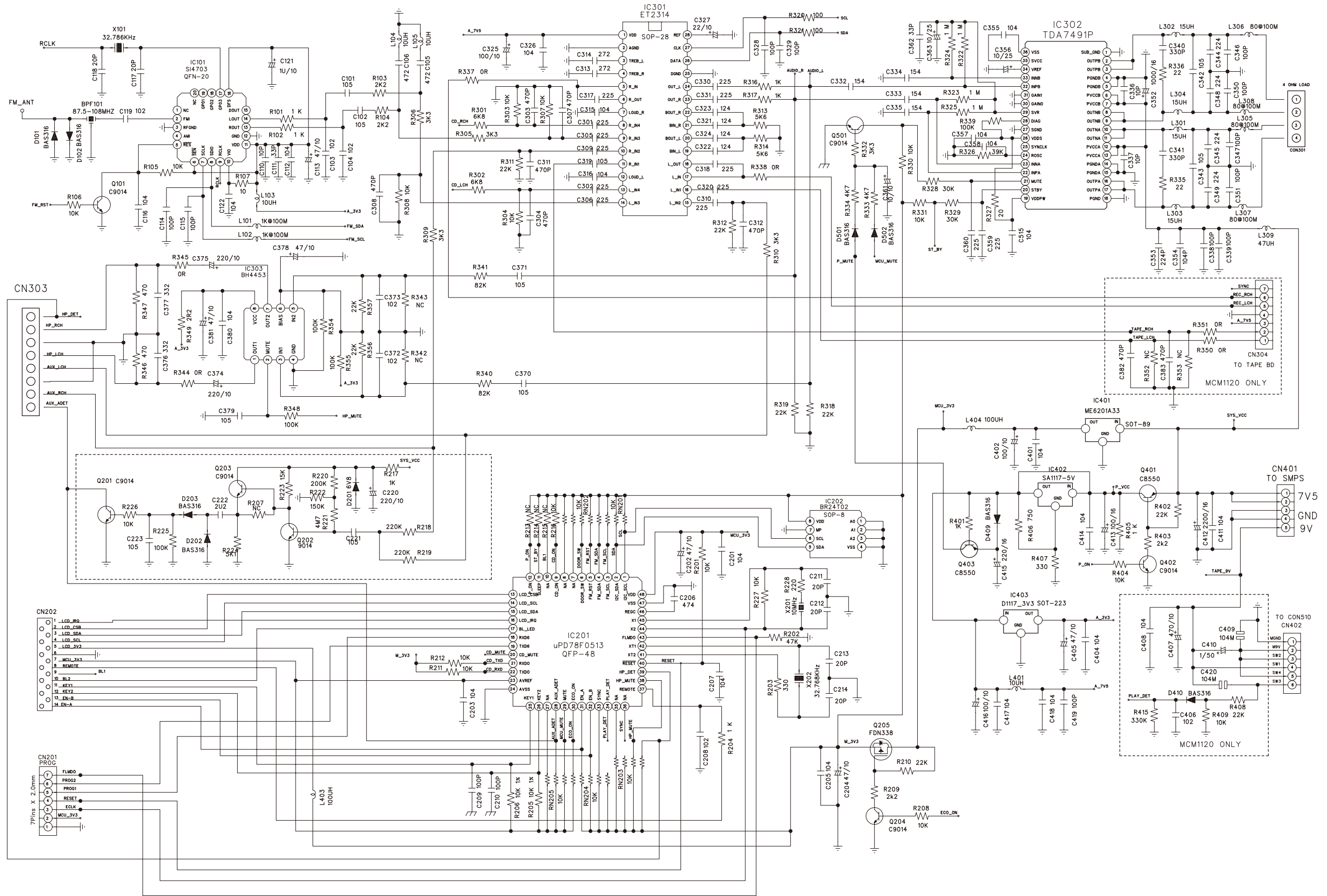

# CIRCUIT DIAGRAM - CD/USB BOARD

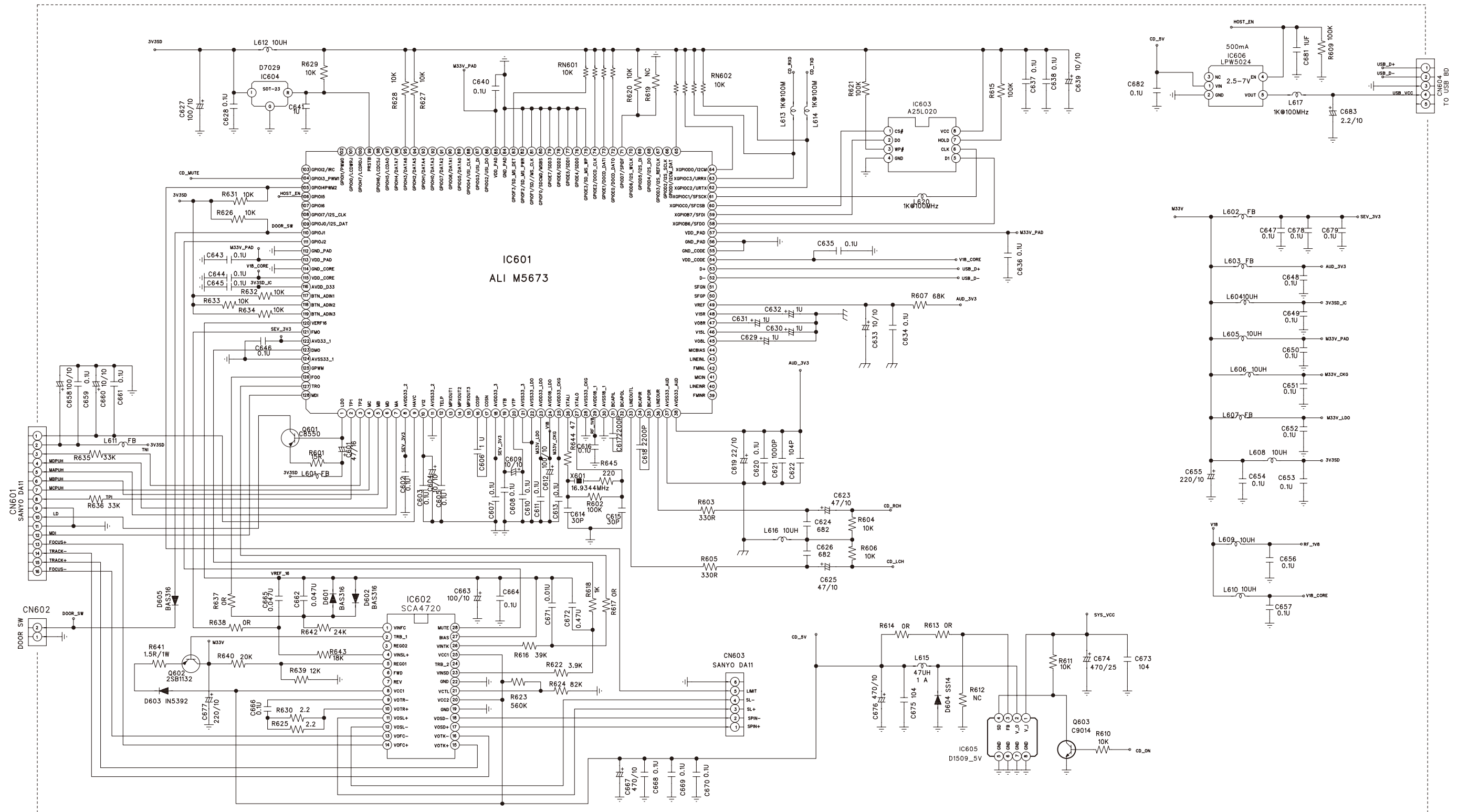

# CIRCUIT DIAGRAM - DISPLAY/KEY BOARD

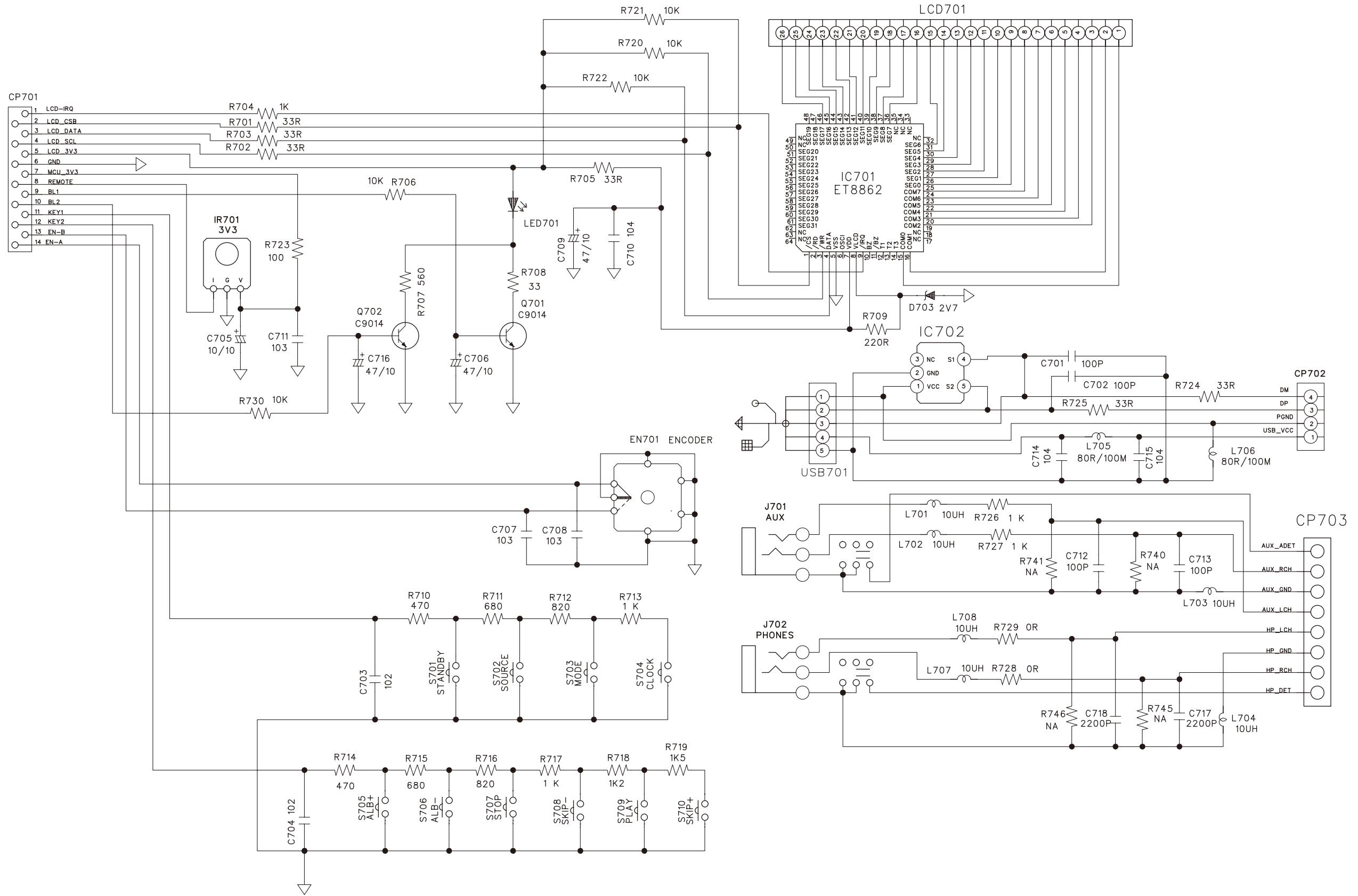

LAYOUT DIAGRAM - MAIN BOARD  
TOP SIDE

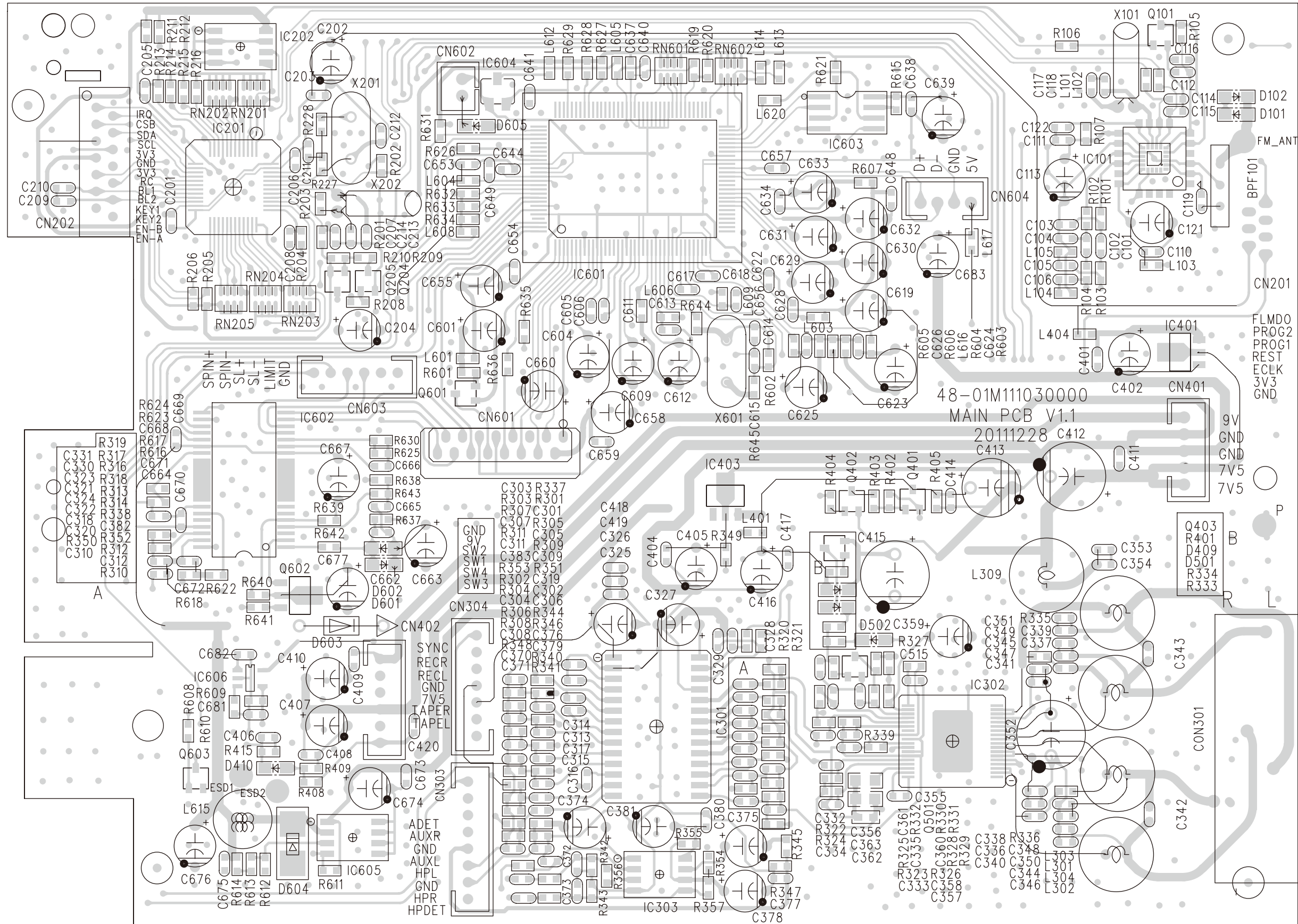

LAYOUT DIAGRAM - MAIN BOARD  
BOTTOM SIDE

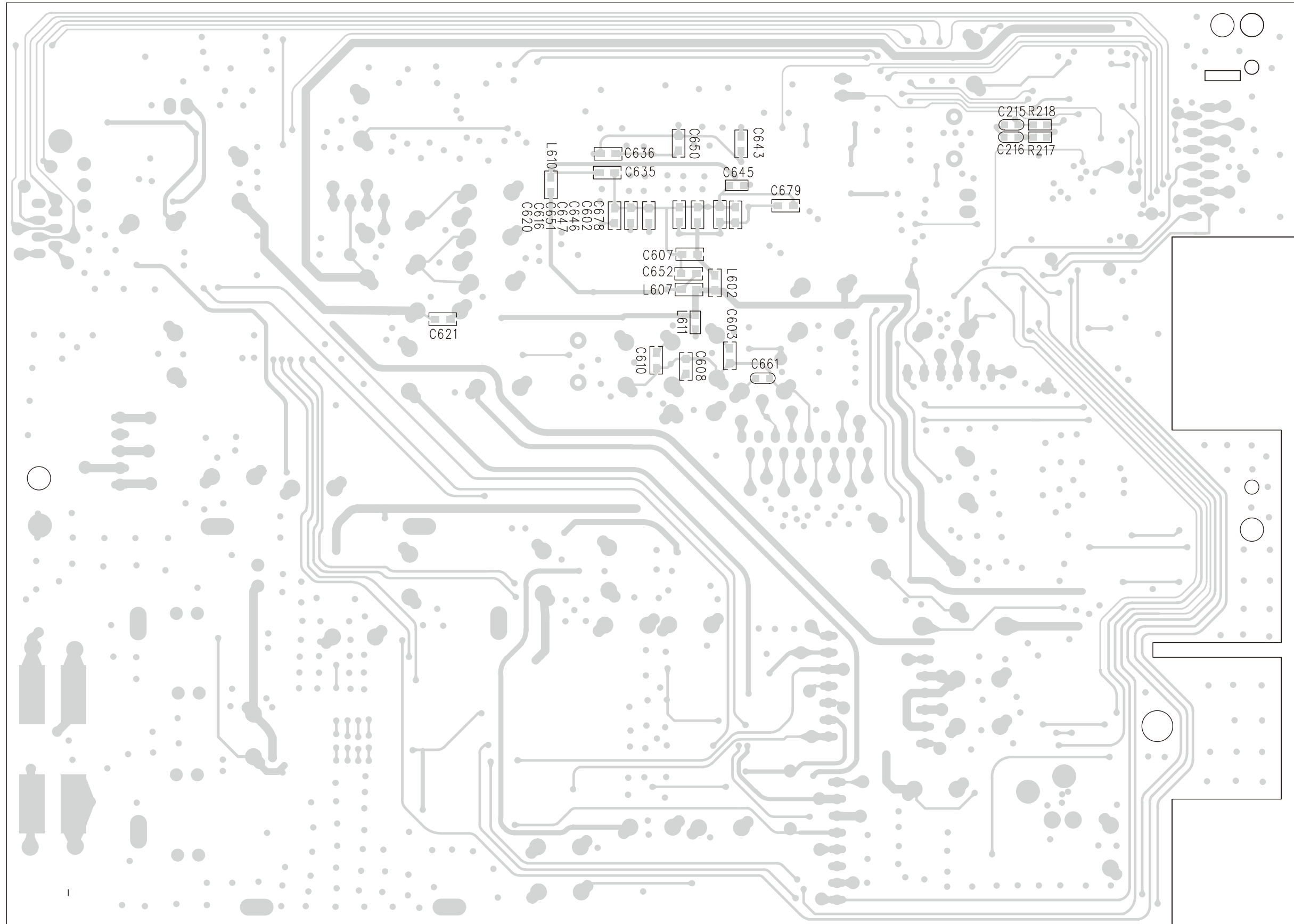



LAYOUT DIAGRAM - DISPLAY BOARD  
TOP SIDE

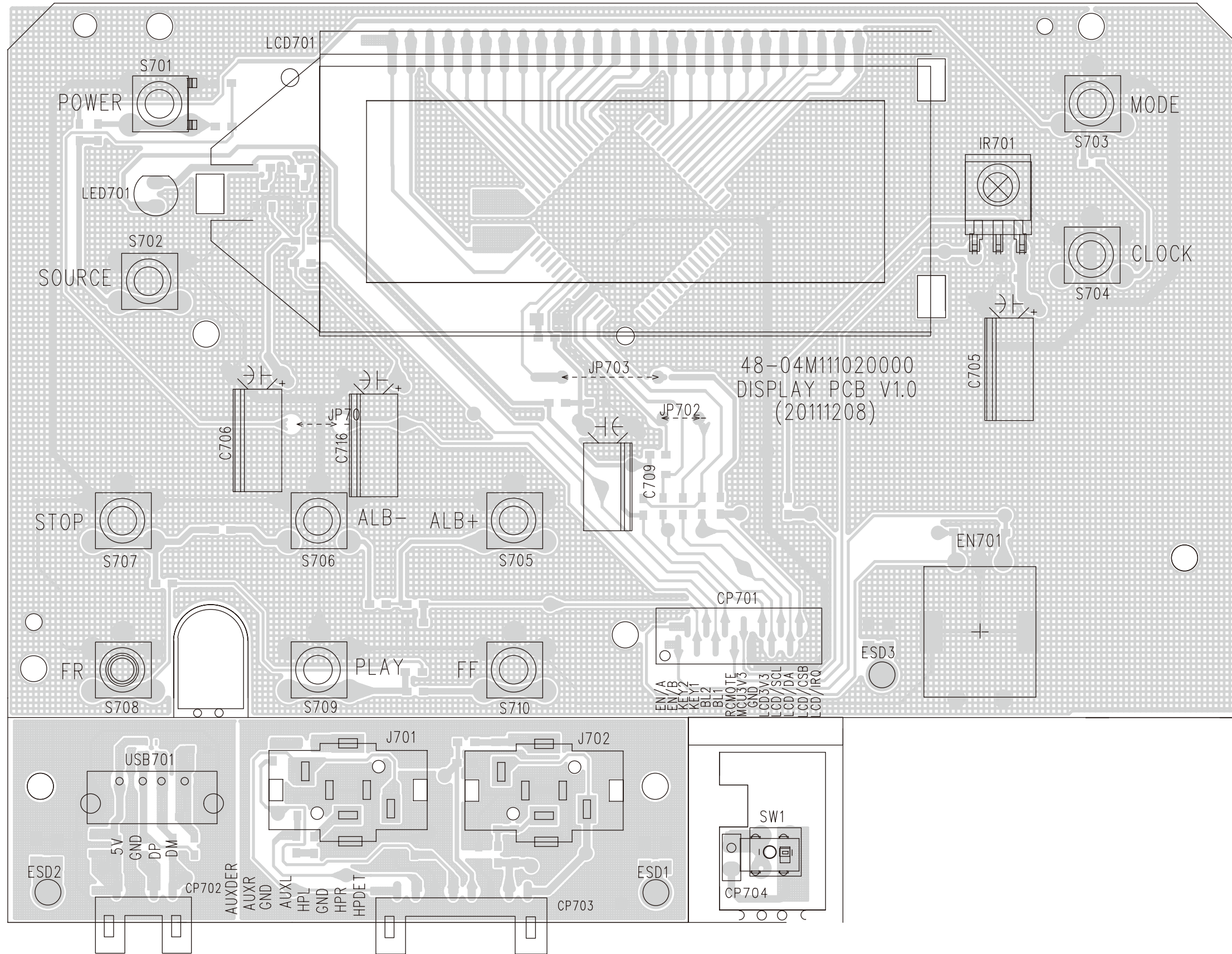

LAYOUT DIAGRAM - DISPLAY BOARD  
BOTTOM SIDE

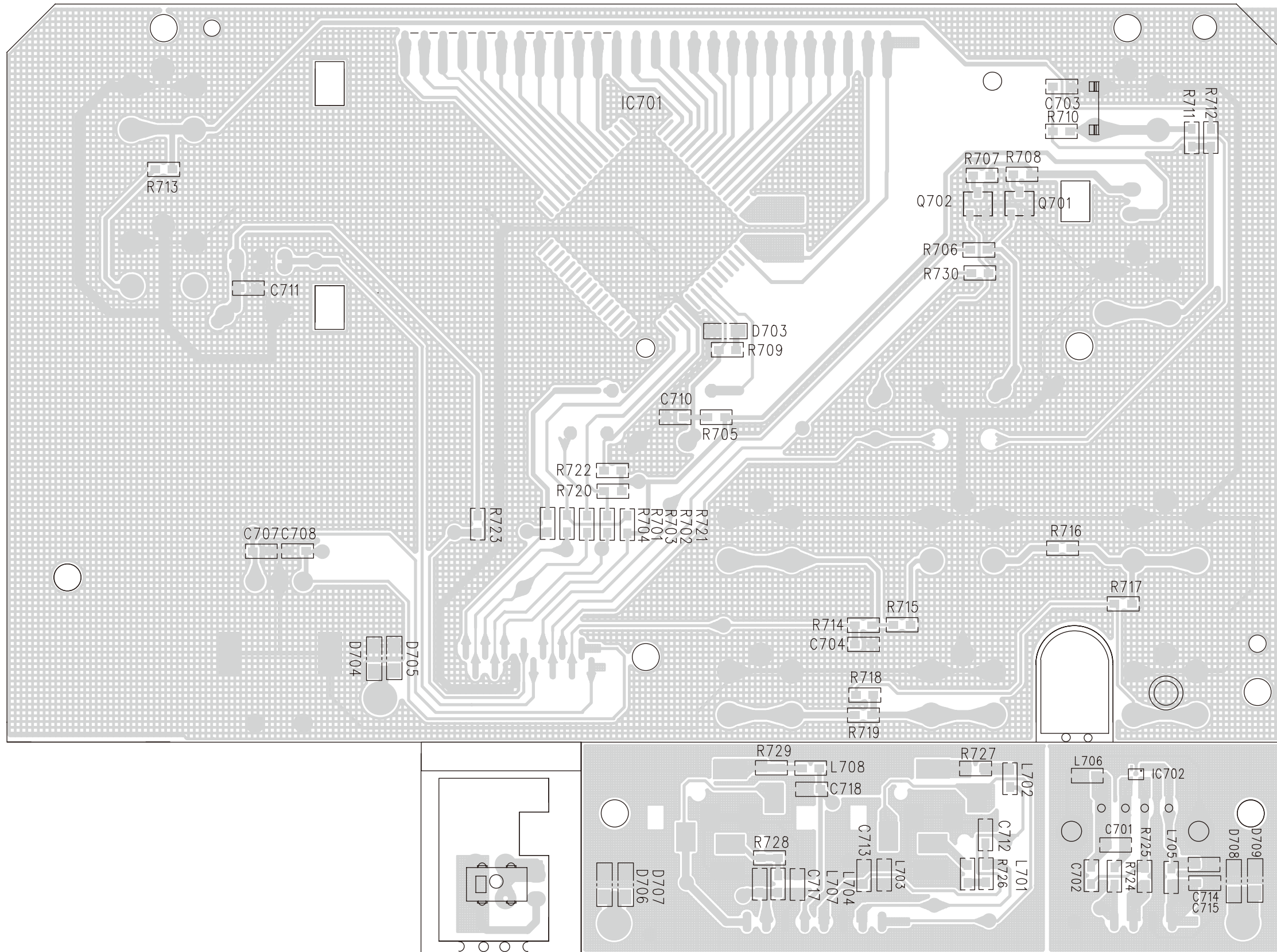

EXPLODED VIEW

